



MIC6211

IttyBitty™ Operational Amplifier

General Description

The MIC6211 IttyBitty™ op amp is a general-purpose, high-performance, single- or split-supply, operational amplifier in a space-saving, surface-mount package.

The MIC6211 operates from 4V to 32V, single or differential (split) supply. The input common-mode range includes ground. The device features a 2.5MHz unity gain bandwidth, 6V/μs slew rate, and is internally unity-gain compensated.

Inputs are protected against reverse polarity (input voltage less than V₋) and ESD (electrostatic discharge). Output is current limited for both sourcing and sinking. Output short circuits of unlimited duration are allowed, provided the power dissipation specification is not exceeded.

The MIC6211 is available in the tiny, 5-lead SOT-23-5 surface-mount package.

Features

- 4V to 32V operation
- Small footprint package
- Unity gain stable
- 2.5 MHz unity gain bandwidth
- 6V/μs typical slew rate
- Short circuit protected

Applications

- Analog blocks
- Active filtering

Ordering Information

Part Number		Marking		Temp. Range	Package
Standard	Pb-Free	Standard	Pb-Free		
MIC6211-BM5	MIC6211-YM5	A11	A11	-40°C to +85°C	SOT-23-5

Pin Configuration

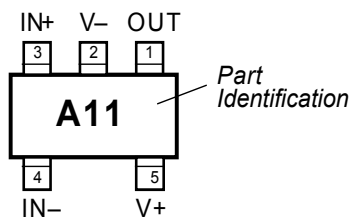

Functional Configuration

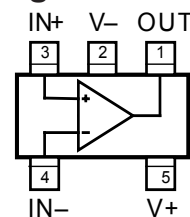

SOT-23-5 (M5)

Pin Description

Pin Number	Pin Name	Pin Function
1	OUT	Amplifier Output
2	V-	Negative Supply: Negative supply for split supply application or ground for single supply application.
3	IN+	Noninverting Input
4	IN-	Inverting Input
5	V+	Positive Supply

IttyBitty is a trademark of Micrel, Inc.

Micrel, Inc. • 2180 Fortune Drive • San Jose, CA 95131 • USA • tel + 1 (408) 944-0800 • fax + 1 (408) 474-1000 • <http://www.micrel.com>

Absolute Maximum Ratings

Supply Voltage ($V_{V+} - V_{V-}$)	36V or $\pm 18V$
Differential Input Voltage ($V_{IN+} - V_{IN-}$)	$\pm 36V$
Input Voltage (V_{IN+}, V_{IN-})	$(V_{V-} - 0.3V)$ to V_{V+}
Output Short Circuit Current Duration	∞

Operating Ratings

Supply Voltage	4V to 32V
Ambient Temperature Range	$-40^{\circ}C$ to $+85^{\circ}C$
SOT-23-5 Thermal Resistance (θ_{JA})	$220^{\circ}C/W$ (mounted to printed circuit board)

Electrical Characteristics (Differential Supply)

$V_+ = +15V$, $V_- = -15V$, $V_{CM} = 0V$; $R_L = 2k\Omega$; $T_A = 25^{\circ}C$, **bold** values indicate $-40^{\circ}C \leq T_A \leq +85^{\circ}C$, $T_A = T_J$; unless noted

Symbol	Parameter	Condition	Min	Typ	Max	Units
V_{OS}	Input Offset Voltage			2	7	mV
TCV_{OS}	Average Input Offset Drift	Note 1		7		$\mu V/^{\circ}C$
I_B	Input Bias Current			50	250	nA
I_{OS}	Input Offset Current			8	30	nA
V_{CM}	Input Voltage Range		+13.5 -15.0	+13.8 -15.3		V V
CMRR	Common Mode Rejection Ratio	$V_{CM} = +13.5V, -15.0V$	65	100		dB
PSRR	Power Supply Rejection Ratio	$V_S = \pm 2.5V$ to $\pm 15V$	65	110		dB
A_{VOL}	Large Signal Voltage Gain	$V_O = \pm 10V$	25	180		V/mV
V_{OUT}	Maximum Output Voltage Swing		± 12.5	± 14		V
B_W	Bandwidth			2.5		MHz
S_R	Slew Rate			6		V/ μs
I_{SC}	Output Short Circuit Current	Sourcing or sinking	30	50		mA
I_S	Supply Current			1.3	2.0	mA

Electrical Characteristics (Single Supply)

$V_+ = +5V$, $V_- = 0V$, $V_{CM} = 0.1V$; $T_A = 25^{\circ}C$, **bold** values indicate $-40^{\circ}C \leq T_A \leq +85^{\circ}C$, $T_A = T_J$; unless noted

Symbol	Parameter	Condition	Min	Typ	Max	Units
V_{OS}	Input Offset Voltage			2	7	mV
TCV_{OS}	Average Input Offset Drift	Note 1		7		$\mu V/^{\circ}C$
I_B	Input Bias Current			65	250	nA
I_{OS}	Input Offset Current			8	30	nA
V_{CM}	Input Voltage Range		+3.5 0	+3.7 -0.3		V V
CMRR	Common Mode Rejection Ratio	$V_{CM} = 0V$ to 3.5V	45	70		dB
PSRR	Power Supply Rejection Ratio	$V_S = \pm 2.5V$ to $\pm 15V$	65	105		dB
A_{VOL}	Large Signal Voltage Gain	$V_O = 1.5V$ to 3.5V, $R_L = 2k$	15	170		V/mV
V_{OUT}	Maximum Output Voltage Swing	$R_L = 10k$ to GND $R_L = 10k$ to +5V	+3.8	+4.0 +1.0	+1.2	V V
I_{SC}	Output Short Circuit Current	Sourcing or sinking	20	40		mA
I_S	Supply Current			1.2	1.8	mA

General Note: Devices are ESD protected; however, handling precautions are recommended.

Note 1: Not production tested.

Typical Characteristics

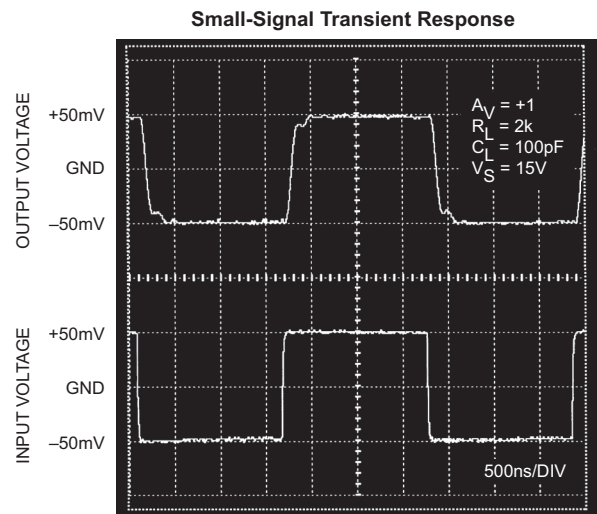
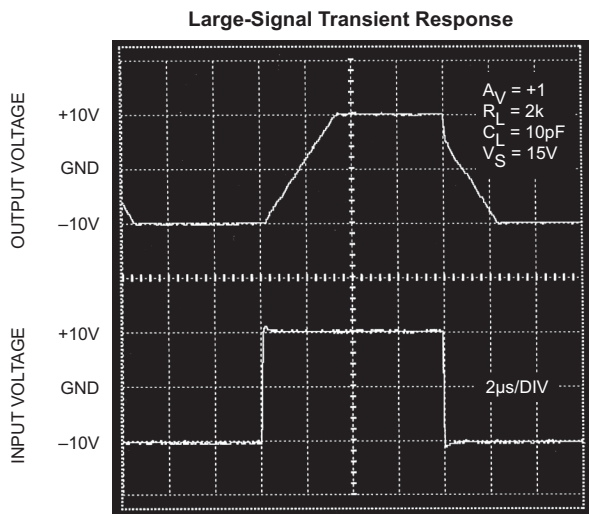
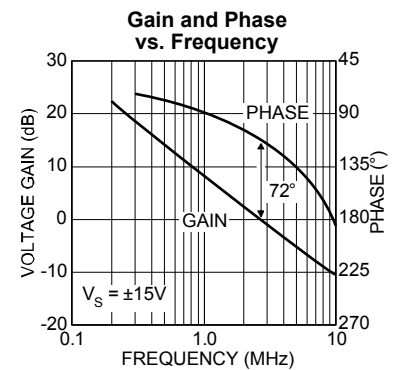
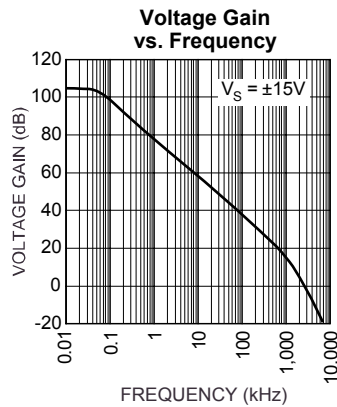
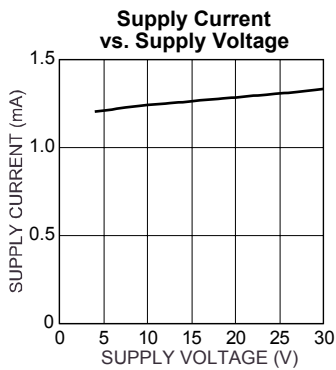
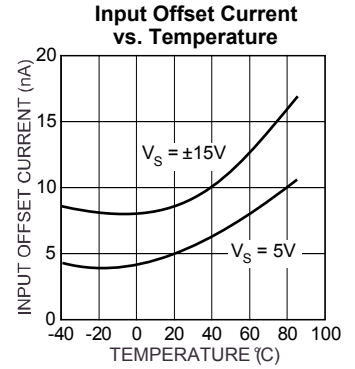
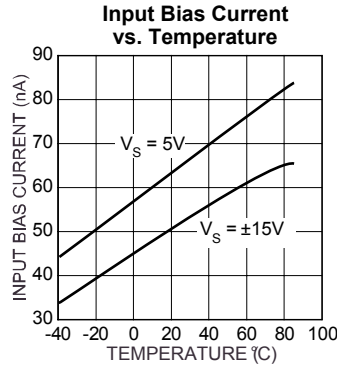
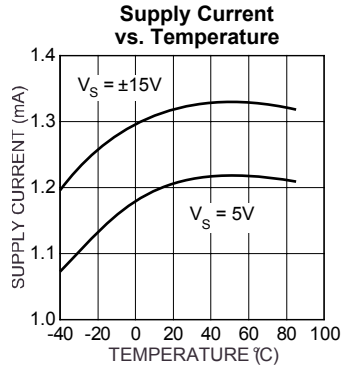

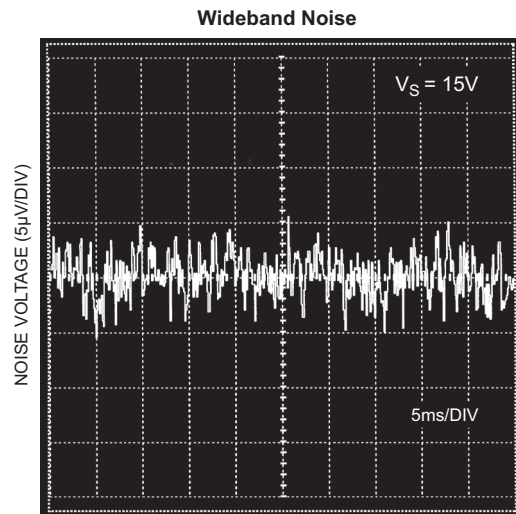
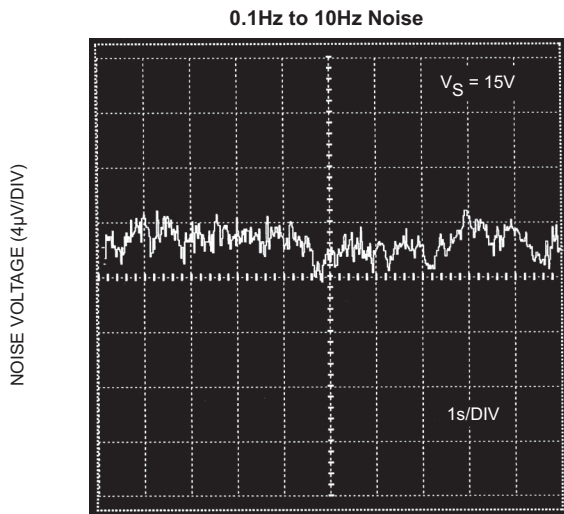
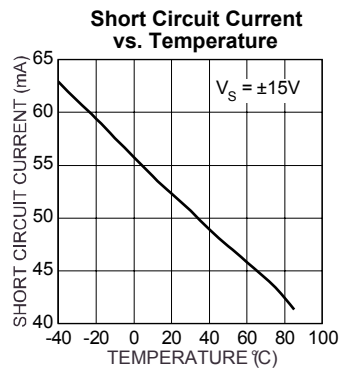
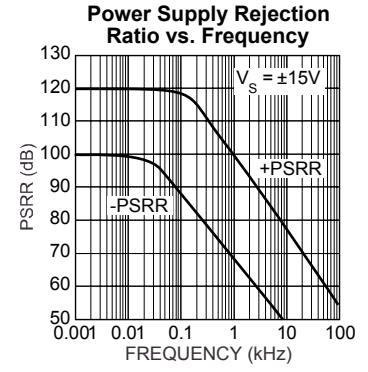
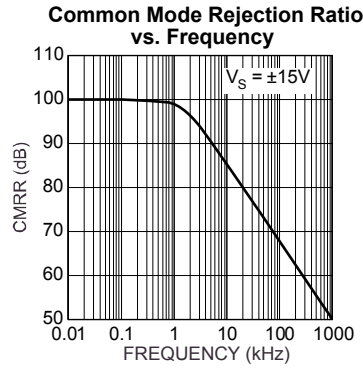
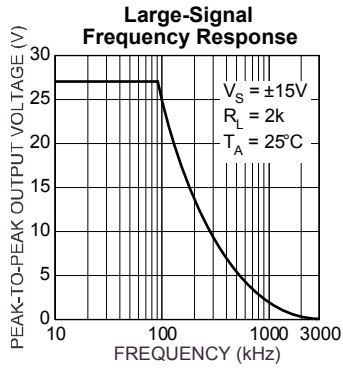

Functional Diagram

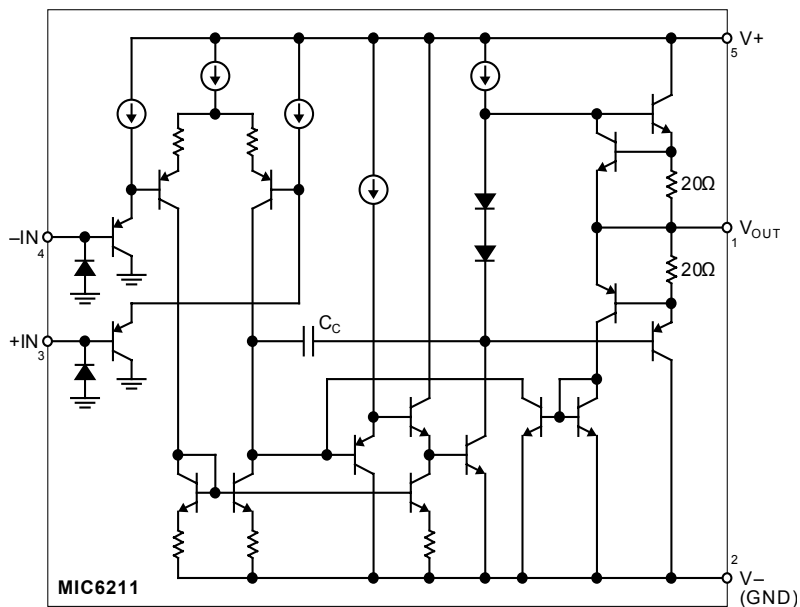

Applications Information

Common-Mode Range and Output Voltage

The input common-mode range of the MIC6211 is from the negative supply voltage to 1.2V below the positive supply voltage. The output voltage swings within 1V of the positive and negative supply voltage.

Voltage Buffer

Figure 1 shows a standard voltage follower/buffer. The output voltage equals the input voltage. This circuit is used to buffer a high impedance signal source. This circuit works equally well with single or split supplies.

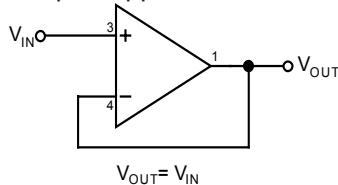

Figure 1. Voltage Buffer

Inverting Amplifier

Figure 2 shows an inverting amplifier with its gain set by the ratio of two resistors. This circuit works best with split supplies, but will perform with single supply systems if the non-inverting input (+ input) is biased up above ground.

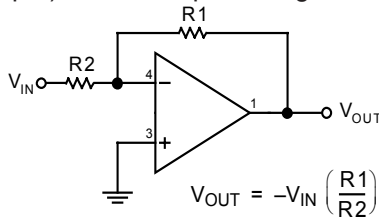

Figure 2. Inverting Amplifier

Voltage Controlled Current Sink

Figure 3 is a voltage controlled current sink. A buffer transistor forces current through a programming resistor until the feedback loop is satisfied. Current flow is V_{IN}/R . This circuit works with single or split supplies.

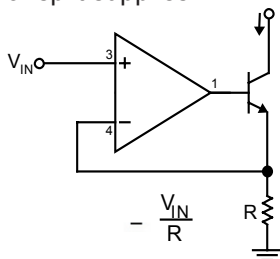

Figure 3. Voltage Controlled Current Sink

High-Pass Filter

Figure 4 is an active filter with 20dB (10x) gain and a low-frequency cutoff of 10Hz. The high gain-bandwidth of the MIC6211 allows operation beyond 100kHz. This filter configuration is designed for split supplies.

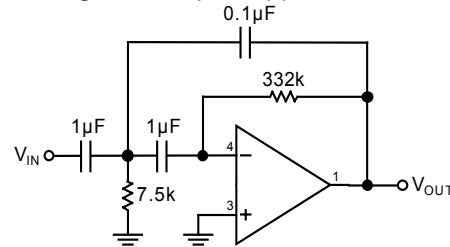

Figure 4a. High-Pass Filter

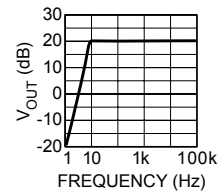
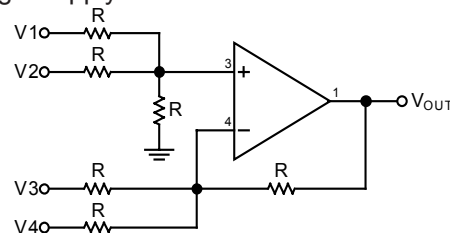

Figure 4b. High-Pass Filter Response

Summing Amplifier

Figure 5 is a single supply summing amplifier. In this configuration, the output voltage is the sum of V1 and V2, minus the sum of V3 and V4. By adding more resistors to either the inverting or non-inverting input, more voltages may be summed. This single supply version has one important restriction: the sum of V1 and V2 must exceed the sum of V3 and V4, since the output voltage cannot pull below zero with only a single supply.



All resistors are equal.

$$V_{OUT} = V1 + V2 - V3 - V4$$

$V1 + V2 > V3 + V4$ for single supply operation

Figure 5. Summing Amplifier

Package Information

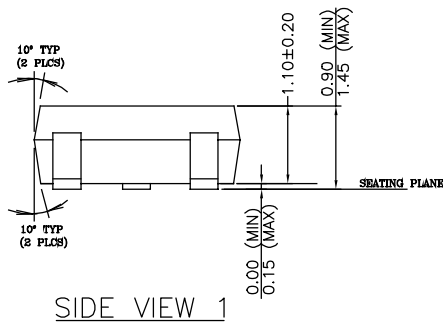
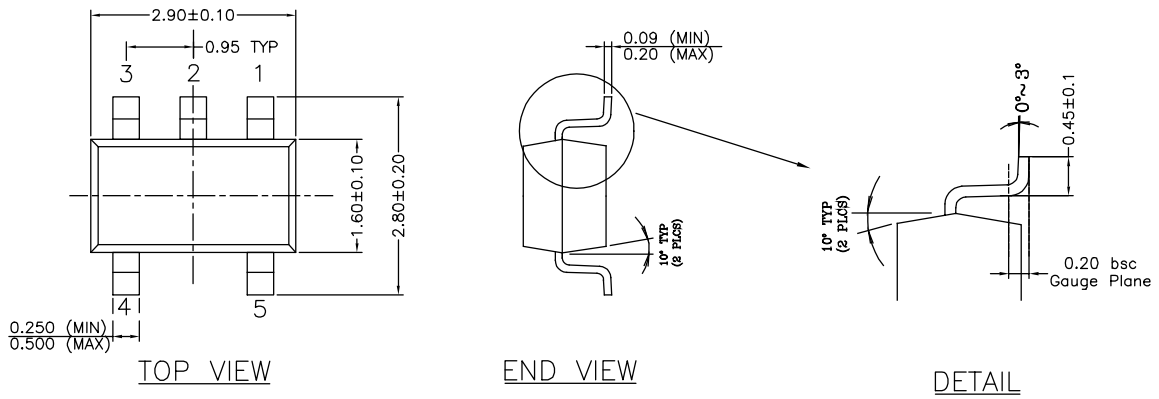

- NOTE:
1. PACKAGE OUTLINE EXCLUSIVE OF MOLD FLASH & BURR.
 2. PACKAGE OUTLINE INCLUSIVE OF SOLER PLATING.
 3. DIMENSION AND TOLERANCE PER ANSI Y14.5M, 1982.
 4. FOOT LENGTH MEASUREMENT BASED ON GAUGE PLANE METHOD.
 5. DIE FACES UP FOR MOLD, AND FACES DOWN FOR TRIM/FORM.

SOT-23-5 (M5)

MICREL, INC. 2180 FORTUNE DRIVE SAN JOSE, CA 95131 USA
TEL + 1 (408) 944-0800 FAX + 1 (408) 474-1000 WEB <http://www.micrel.com>

The information furnished by Micrel in this data sheet is believed to be accurate and reliable. However, no responsibility is assumed by Micrel for its use. Micrel reserves the right to change circuitry and specifications at any time without notification to the customer.

Micrel Products are not designed or authorized for use as components in life support appliances, devices or systems where malfunction of a product can reasonably be expected to result in personal injury. Life support devices or systems are devices or systems that (a) are intended for surgical implant into the body or (b) support or sustain life, and whose failure to perform can be reasonably expected to result in a significant injury to the user. A Purchaser's use or sale of Micrel Products for use in life support appliances, devices or systems is at Purchaser's own risk and Purchaser agrees to fully indemnify Micrel for any damages resulting from such use or sale.

© 1999 Micrel, Incorporated.